

FAN BLADE 叶片 Shaded Pole motors' Accessories

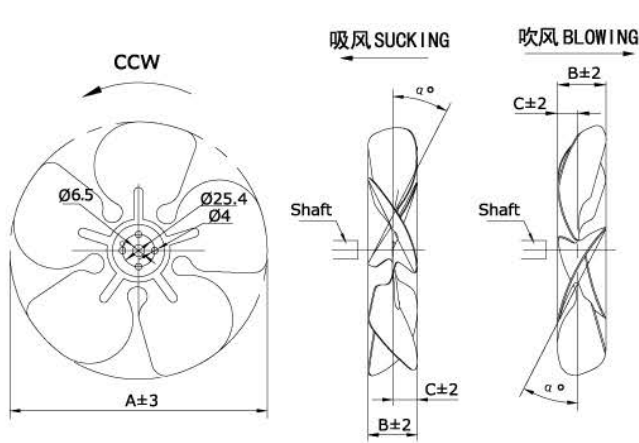

| FAN TYPE | α | 19° | | 22° | | 25° | | 28° | | 31° | | 34° | |
|----------|-----|-----|----|-----|----|-----|----|-----|----|-----|----|-----|----|
| | | A | B | C | B | C | B | C | B | C | B | C | B |
| Φ154 | 154 | 23 | 12 | 26 | 13 | 29 | 15 | 32 | 17 | 36 | 18 | 39 | 21 |
| Φ172 | 172 | 25 | 13 | 28 | 14 | 31 | 16 | 34 | 17 | 38 | 19 | 41 | 21 |
| Φ200 | 200 | 27 | 14 | 30 | 15 | 33 | 17 | 36 | 19 | 40 | 21 | 43 | 24 |
| Φ230 | 230 | 30 | 15 | 33 | 16 | 36 | 19 | 39 | 21 | 42 | 20 | 45 | 23 |
| Φ250 | 248 | 31 | 15 | 34 | 16 | 37 | 19 | 40 | 20 | 43 | 21 | 45 | 23 |
| Φ254 | 254 | 32 | 15 | 35 | 16 | 38 | 19 | 41 | 21 | 44 | 22 | 47 | 23 |
| Φ300 | 300 | 32 | 16 | 35 | 17 | 41 | 21 | 44 | 22 | 48 | 24 | 52 | 26 |



| TYPE | YZF2-13 | | YZF5-13 | | YZF7-20 | | YZF10-20 | | YZF12-20 | | YZF16-25 | | YZF18-30 | | YZF25-40 | | YZF34-45 | | |
|------|---------|------|---------|------|---------|------|----------|------|----------|------|----------|------|----------|------|----------|------|----------|------|--|
| | 50Hz | 60Hz | 50Hz | 60Hz | 50Hz | 60Hz | 50Hz | 60Hz | 50Hz | 60Hz | 50Hz | 60Hz | 50Hz | 60Hz | 50Hz | 60Hz | 50Hz | 60Hz | |
| Φ154 | 28 | 28 | | | | | | | | | | | | | | | | | |
| Φ172 | 28 | 28 | 31 | 31 | | | | | | | | | | | | | | | |
| Φ200 | | | 28 | 28 | 31 | 31 | 31 | 31 | | | | | | | | | | | |
| Φ230 | | | | | 28 | 28 | 28 | 28 | 34 | 31 | | | | | | | | | |
| Φ250 | | | | | | | 22 | 22 | 28 | 28 | 28 | 28 | | | | | | | |
| Φ254 | | | | | | | | | | | 28 | 25 | 31 | 28 | | | | | |
| Φ300 | | | | | | | | | | | | | 22 | 22 | 25 | 22 | 28 | 25 | |



GRID 网罩 Shaded Pole motors' Accessories

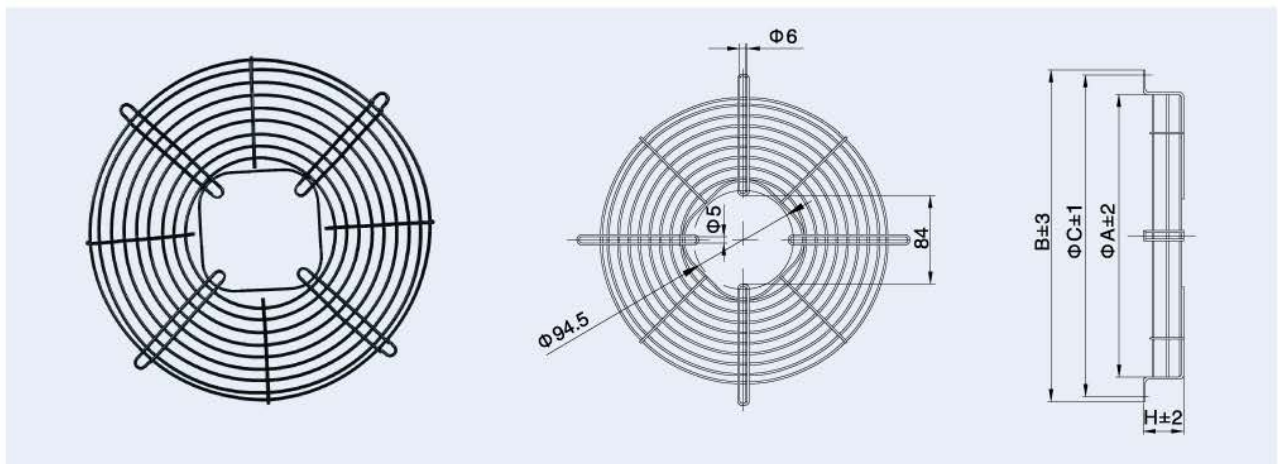

| TYPE | Φ154 | Φ172 | Φ200 | Φ230 | Φ254 | Φ300 |
|------|------|------|------|------|------|------|
| A | 170 | 188 | 214 | 246 | 270 | 324 |
| B | 202 | 220 | 248 | 278 | 302 | 356 |
| C | 190 | 208 | 236 | 266 | 290 | 344 |
| H | 11 | 11 | 25 | 27 | 17 | 17 |



YZF 风量曲线 Air Flow

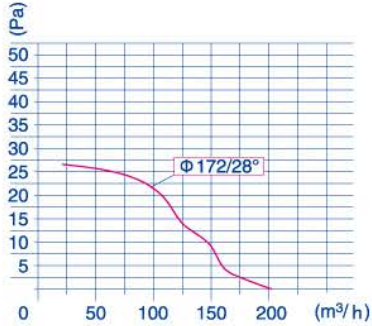

YZF2-13 50Hz Air Flow 空气量

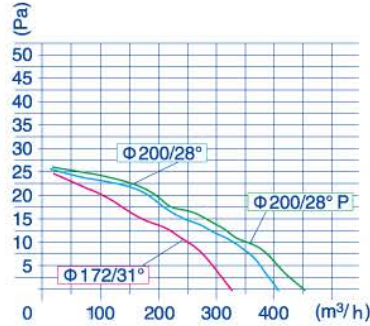

YZF5-13 50Hz Air Flow 空气量

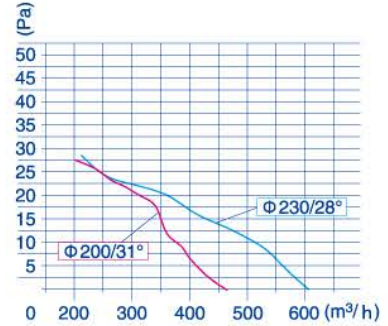

YZF7-20 50Hz Air Flow 空气量

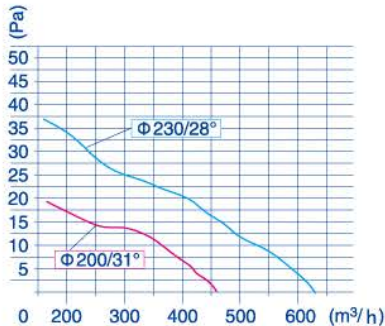

YZF10-20 50Hz Air Flow 空气量

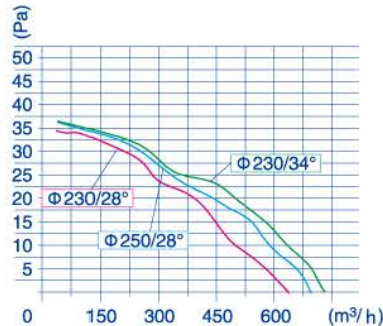

YZF12-20 50Hz Air Flow 空气量

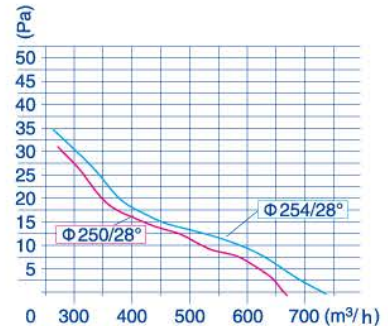

YZF16-25 50Hz Air Flow 空气量

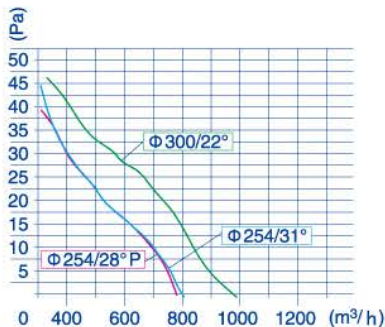

YZF18-30 50Hz Air Flow 空气量

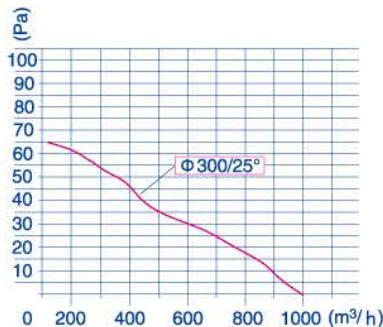

YZF25-40 50Hz Air Flow 空气量

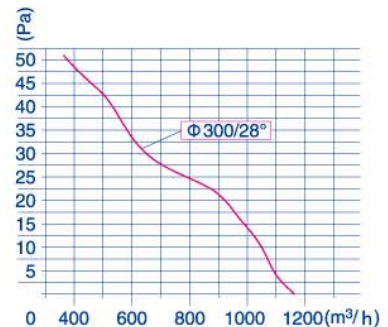

YZF34-45 50Hz Air Flow 空气量

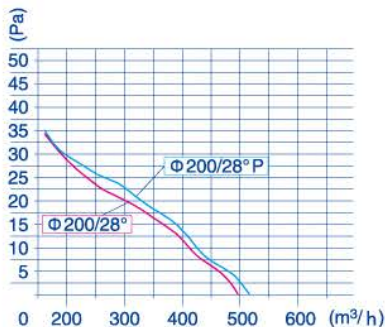

YZF6-13 60Hz Air Flow 空气量

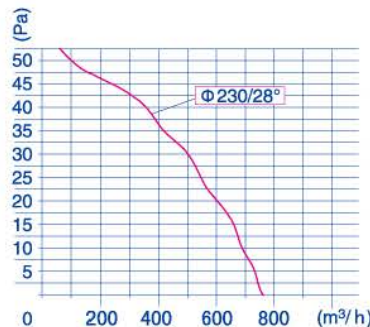

YZF10-20 60Hz Air Flow 空气量

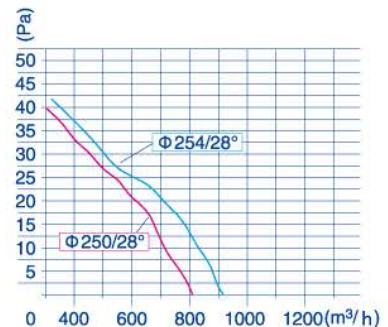

YZF18-25 60Hz Air Flow 空气量